

縦枠 (梱包数2)

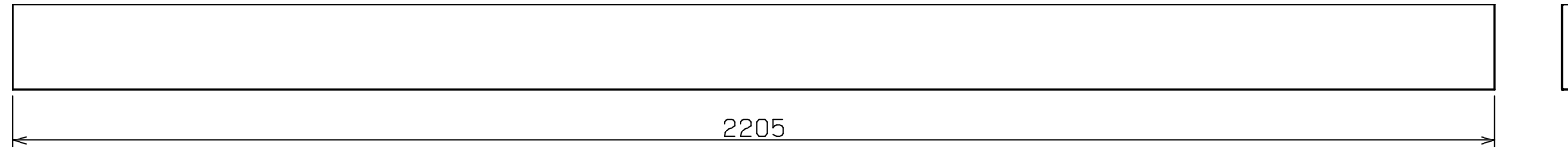

上枠 (梱包数1)

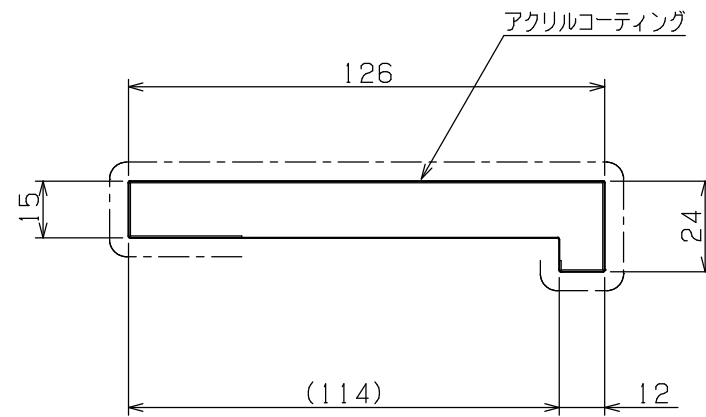
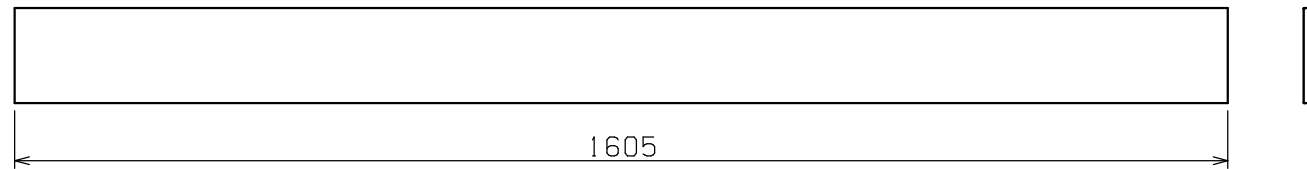

縦枠 断面図 (SCALE 1/2)

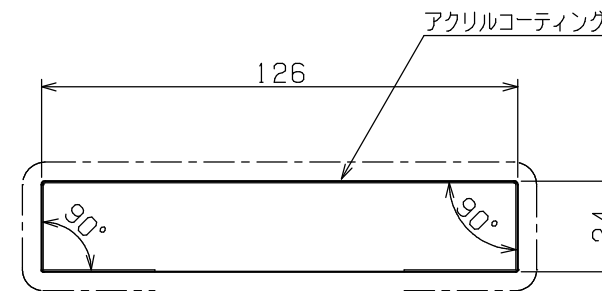

上枠 断面図 (SCALE 1/2)

検 査
CHECKED BY

検 査
CHECKED BY

DESIGNED BY	年 月 日	氏 名	名 称 TITLE	抗菌樹脂枠 三方枠複合タイプ SP-7005UM24-WT	尺 度 SCALE	1/10
DRAWING BY			図 番 DWG. NO		第三角法 3RD ANGLE PROJECTION	
符号	変 更	REVISIONS	日 付	担 当	承 認 APPROVED BY	
△						
△						
△						
△						